

**YONGNUO**  
DIGITAL

# TTL闪光灯 SPEEDLITE YN968N



使用说明书  
INSTRUCTION MANUAL

在使用本产品之前，请通读本手册，以确保您能正确、安全使用，然后保存好本手册以便将来查询参考。

Before use, please read this user manual carefully in order to ensure your safety. Keep it properly for reference in the future.



## Contents

Precaution . . . . .	1
Features . . . . .	2
Quick Start. . . . .	3
Components Description. . . . .	4
LCD Panel . . . . .	5-6
Installation Instruction. . . . .	7
Basic Operations . . . . .	8-10
Wireless Flash Shooting . . . . .	12-14
Advanced Applications . . . . .	15-17
C.Fn/P.Fn: Setting Custom /Personal Functions . . . . .	18-19
Shooting with LED Light . . . . .	20
Troubleshooting . . . . .	21
Specifications . . . . .	22

## Precaution

- To avoid fire or electrical shock, do not expose this product to rain or moisture.
- To avoid short circuit, please make sure the batteries contacts are securely packed and use the battery in accordance with the local provisions.
- Please place the batteries and the parts which can be swallowed mistakenly away from children. If swallowed, please get medical help immediately.
- To avoid any possible injury to eyes, do not use the flash in a short distance from the eyes.
- To avoid any possible safety accident, do not use the flash on the people focusing attention.
- Please take out the batteries and stop using this product immediately in case of the following situation:
- This product is dropped or shocked seriously and the inner part of this product is bared.
- Wear gloves and take the batteries out if the corrosive liquid inside the batteries leaks.
- This product gives off strange smell, heat or smokes.
- Do not disassemble or maintain this product because the internal high voltage circuit may cause the electric shock.
- Please take out all the batteries if this product is not used for a long time.

## Features

- **Equipped with LED Light**

Equipped with a high power LED light of high power, brightness can be adjusted, there is a built -in diffuser and a color conversion filter for the LED light.

- **Compatible with YN622N and YN560 Wireless System**

When YN968N is used as master unit, it can control and fire YN968N/YN622N(II)/YN685N being slave unit. When YN968N is set as YN622 (slave mode), it can received control signal or trigger signal from master unit YN968N/YN622N(II)/YN622N-TX, and achieves slave flash in TTL/M/Multi mode. When YN968N is set as YN560 (slave mode), it can receive control signal or trigger signal from YN560-TX (II)/RF603 (II)/RF605, and achieves flash in M/Multi mode.

- **High Guide Number, Supports High-speed Sync**

GN60@ISO100,105mm, supports high-speed sync TTL, manual flash, multi flash, Gr grouping flash, the highest synchronous speed can reach 1/8000s.

- **Support Auto/Manual Zooming**

The YN968N supports auto and manual zooming, the flash coverage can be changed between AUTO, 20~105mm.

- **Supports USB Firmware Upgrade**

The YN968N equipped with the USB interface, supports firmware upgrade, the users can download the upgrade firmware through the Yongnuo official website to upgrade the flash.

- **Supports Wireless Optical Slave function**

The YN968N supports receiving YONGNUO, Canon' s and Nikon' s wireless optical master signal, supports S1 and S2 flash mode.





- **Settings Save Automatically, Supports Custom Functions (C.Fn), Personal Functions(P.Fn).**

- **Ultra fast Charging Recycle System, Supports External Power Supply**

- **Equipped with Big Size LCD Display Screen, Standard PC Synchronous Interface**

## Quick Start

If you don't have much time to read the whole user manual, we advise you to read this section.

1. Please avoid the excessive use of the output with maximum power. It can effectively extend the service life of this product. (It is recommended that the speedlite should be idle for more than 10 minutes when entering the overheat protection).
2. Press [] button to switch trigger methods (on-top , radio wireless master, radio wireless slave and optical slave) sequentially. When YN968N is in set-top mode, press [MODE] button to switch flash mode.
3. Function button 1-4 corresponding to different functions according to current state of the flash, operations and details please refer to the following chapters.
4. When YN968N is used as master unit, press [CH] button to enter into channel setting status, press [GR] button to switch groups, operate [ON/OFF] button to set whether the group participating flash, press function button [MODE] to switch flash mode, and rotate [] to set flash exposure compensation or flash output.
5. Short press the function button [] can enter into the focal length setting state. long press the function button [] can enter into the advanced options setting state, then through the [] and [OK] buttons can set the coverage of the focal length and the custom function/personal functions.
6. Long press the function button 2 and button 3 can set the flash shooting function settings and wireless shooting setting recover to the default set-top TTL flash mode status.
7. Make the flash unit vertical, press the [LED] button , the LED comes on, the LED lighting on the LCD panel, press the LED button again turning off the LED light.
8. When you position the flash head down by 7° , you can shoot subjects at a short distance in a range of approx. 0.5 to 2 m.

## Components Description

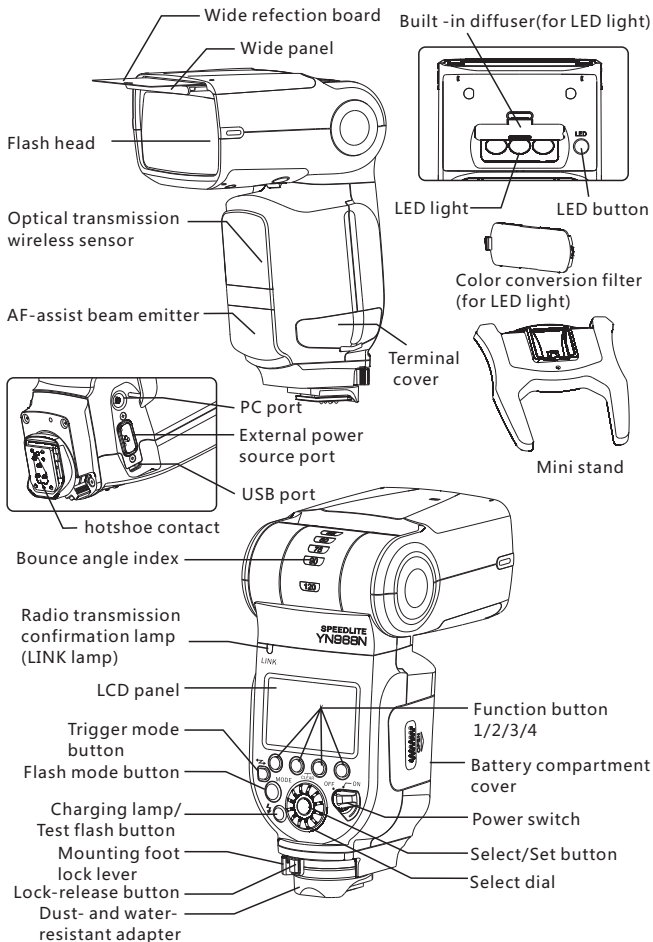

## LCD Panel

### TTL flash

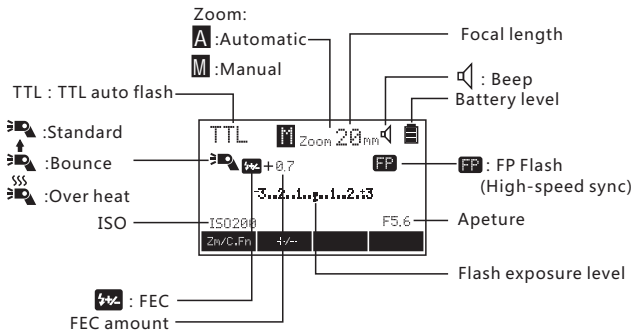

### Manual flash

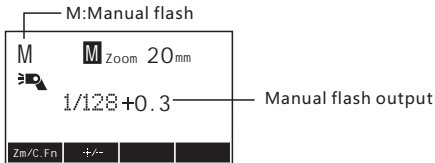

### Multi(stroboscopic) flash

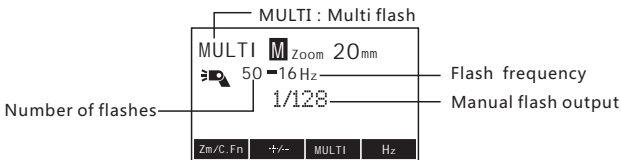

## LCD Panel

Press button [  ] can switch the trigger mode: set-top, radio wireless master mode, radio wireless slave mode, optical wireless slave mode(include SC/SN/SC&SN/S1/S2)

:Set-top flash



: Radio wireless master mode **MASTER**

: Master

 622 : YN622 MODE

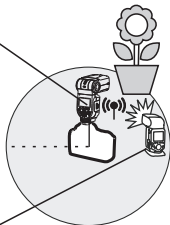

: Radio wireless slave mode **SLAVE**

: Slave

 622 : YN622 MODE

 560 : YN560 MODE

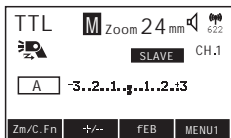

:Optical wireless slave mode **SLAVE**

:Slave

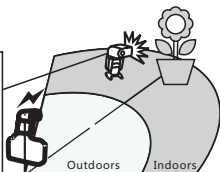
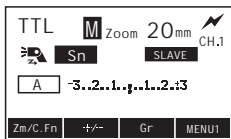

# Installation Instruction

## 1. Install Batteries

Slide the battery compartment cover in the direction of the arrow as shown. Insert the batteries according to the label inside battery compartment and make sure the direction of the battery contact (+/-) is correct. Close the battery compartment cover in the direction of the arrow as shown.

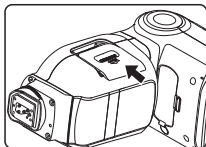
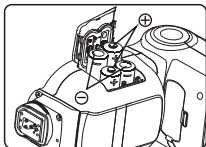
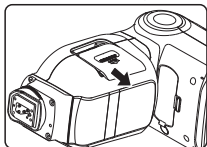

**⚠ WARNING: LiFePO4 and/or Li-ion type batteries ARE NOT COMPATIBLE, PLEASE USE alkaline or NiMH type batteries! To avoid circuit, please do not use damaged batteries.**

## 2. Attaching to the Camera & Detaching from the Camera

Slip the speedlite's mounting foot all the way into the camera's hot shoe. Slide the mounting foot lock lever to the right side as the arrow shown, until heard the "clicks" sound.

To detach the speedlite, press the **[lock-release button]** and slide the **[Mounting foot lock lever]** to the left side, then detach the speedlite.

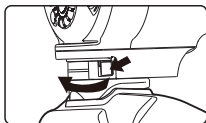
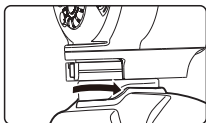
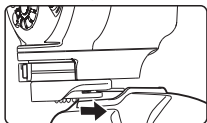

## 3. Power-on and Power-off

Set the power switch to **[ON]** position, the speedlite will turn on and start charging. After turned on, the **[Charging lamp]** will bright with red light which indicates it can flash. After use, set the switch to **[OFF]** position to turn off the power source. Please take out the batteries after turning off the power of the speedlite.

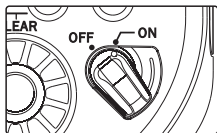

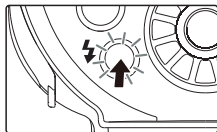

## 4. Test Flash

When the charging lamp turns red, you can test the flash is normal or through the **[TEST]** button.



# Basic Operations

## 1.Button Operation

[ON/OFF]switch	Set the switch to the ON/OFF can turn on/off the power source
[MODE]button	Through the button can switch between TTL/M/MULTI
[  ]Trigger mode button	Short press the button can switch the trigger mode: set-top, radio wireless master , radio wireless slave, optical wireless slave(SC/SN/SC&SN/S1/S2)
[  ]Select dial	Through the dial can adjust the selected parameters which need adjusted, related operations and details please refer to the subsequent chapters
[  ]Select/OK button	Confirm and save the parameter settings
[Function button 1/2/3/4]	According to the current state of the flash, the corresponding four function buttons are in different roles, related operations and details please refer to the subsequent chapters
[TEST] button	Test flash

## 2.Statues of [Charging Indicator]

Statues	Meaning	Method
Red light	The speedlite is fully charged and can be used.	Normal
Green light	Quick flash* ready	The speedlite can be used with "quick flash"
Goes off	The speedlite has not been fully charged.	Waiting for completion of fully charged

### \*About Quick Flash

The Quick Flash function enables flash shooting while the charging lamp is green (before the flash is fully charged).The guide number is 1/2 to 1/6 of the full output, but it is useful for shooting with a faster recycling time at a short shooting distance.

## 3.Meaning of [Link lamp]

[LINK] lamp statues	Meaning	Method
Green light	Radio transmitting	Normal
Red light	Flash Triggering	Normal

## Basic Operations

### 4. The meaning of [Sound Prompt]

The Sound Form	Meaning	Method
Tick---a long sound	The speedlite is fully charged, and can be used	Normal
Three tick, two times	The exposure maybe excessive	Adjust exposure compensation or change shooting condition
Tick tick tick	The exposure may be insufficient	Adjust exposure compensation or change shooting condition
Tick-tick tick tick tick	Overheat protection prompt	Idle 10 minutes for overheat released.
Tick-tick-tick	Low battery and the speedlite is about to shut down	Replace the batteries

### 5. TTL Mode

In TTL mode, the metering system of this camera will detect flash illumination reflected back from the object so as to automatically adjust the exposure compensation.

In TTL mode, the light intensity can be adjusted by setting FEB, FEC and flash exposure lock(FVL).



### 6. M Mode

In M mode, you can set flash output as your requirement by short press the function button [ +/- ], you can adjust the flash output through [ ]. Adjustment range of flash output is 1/128-1/1, and the output can be divided into 8 grades, each has maximum 3 grades for fine adjustment, with grade 0.3EV, 0.7EV as adjustment increment, totally 29 grade fine adjustment.

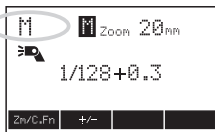

### 7. Multi (stroboscopic) Mode

Multi mode, the speedlite will flash according to the flash output, flash frequency and number of flashes you set. Select the number of flashes through the function button [ MULTI ], select the frequency through the function button [ ]. Then adjust the numbers of flashes and flash frequency through the [ ]. The adjustment method of the flash output are same as the M mode. The number of flashes range is 1-100, and the range of flash frequency is 1-199.

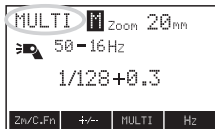

## Basic Operations

### 8.Auto zoom :

Short press the function button [Zm/C.Fn] until the local length value displays on LCD panel, then adjust the coverage through [Z]. When it displays [A], attach the speedlite to the camera, the flash coverage will change as the lens focal length and move back and forth to accommodate different flash coverage .

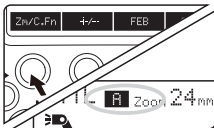

### 9.Manually set the zooming position:

Press the function button [Zm/C.Fn] until the local length value displays on LCD panel, then adjust the coverage through [Z].

If [M] is displayed, you can adjust the flash coverage (20,24,28,35,50,70,80,105mm) manually.

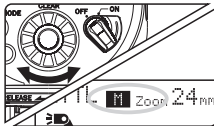

### 10.AF Assist Beam Emitter(C.Fn04)

When using AF under low-light, the built-in AF-assist beam emitter of the speedlite will be emitted automatically to make it easier to autofocus. Please refer to the C.Fn chapters.

### 11. Automatic Setting Saving

The speedlite will automatically save the current settings which will be convenient to your next use.

### 12. Power Saving Mode(C.Fn01)

The power saving mode can be achieved by through custom functions settings, please refer to the C.Fn chapters.

### 13.Overheat protection

When continuous flash, the temperature of the flash head may increase, a warning icon [🔥] icon will be displayed on LCD panel, and the recycling time will be longer.

When repeated firings of the flash, the overheat protection function will be triggered, the LCD is lighting in red, the speedlite will be locked ,in such case, please wait for about 10 minutes before continuing use.



- When the speedlite warns overheat, please reduce the use intensity.
- Please mind the hot batteries when you take them out after the continuous shooting.

### 14.About Battery Capacity

When the battery capacity is insufficient, the screen is as shown in figure, and please change the batteries.



## Wireless Flash Shooting: Radio Transmission

YN968N speedlite supports YN622 mode and YN560 mode radio wireless transmission. Using YONGNUO transmitter or speedlite which supports wireless transmitting can be easily achieved according to the same method of flash photography.

**When YN968N is used as master unit, it can control slave units as below:**YN968N,YN622N,YN622N II,YN685N

**When YN968N is used as slave unit, it can receive signal from master units as below:**

YN968N,YN622N-TX,YN622N,YN622N II(using YN622 mode)

YN560-TX,RF605,RF-603 series products (using YN560 mode)

System design: The settings of the speedlite (mater unit) on the top of the camera automatically reflects in the speedlite (slave unit) being wirelessly controlled. Therefore, there is no need to use a slave unit in shooting. The basic relative position and operating specification show as below.

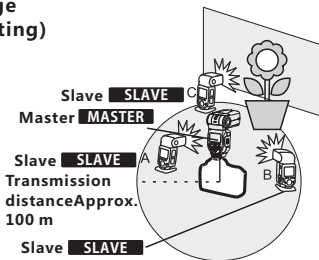

### Positioning and Operation Range (Example of wireless flash shooting)

- Position the slave unit using the supplied mini stand.
- Before shooting, perform a test flash and test shooting.
- The transmission distance may be shorter depending on the conditions such as the positioning of slave units, the surrounding environment and weather conditions.





#### 1. Wireless Master Unit Settings\*

Attach the flash on the camera and set it as the master unit.

- Press [  ] button until [  ] and [ MASTER ] display.

Radio channel setting

- Press the function button 4 until [ CH ] is displayed, press the function button [  ] to choose the current channel, and adjust the channel through [  ], there are 1-7 channel for option.

\*Wireless master unit only supports YN622 mode.

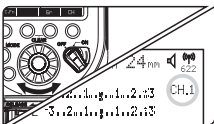
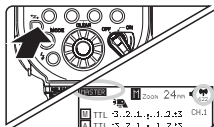

# Wireless Flash Shooting: Radio Transmission

## 2. Wireless Slave Unit Setting -YN622 Mode

Set the other YN968N as slave unit.

- Press [ ] button until [ ] and [ ] icons display, and then set the channel (The setting method is same as master unit. Set the channel of slave unit consistent with as master unit).
- Press function button 3 [ ] to set the groups of slave unit. There are A/B/C groups optional.
- When slave flash is ready, the AF assist beam blinks at one second intervals (It can be disabled through custom function C.Fn04).

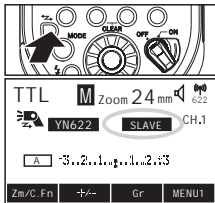

## 3. Set Flash Mode and Group from Master Unit

- Press function button [ ] to enter into group setting status. "M" is short for master unit. A/B/C respectively represents slave unit of A/B/C group.
- Press function button [ ] to set whether the flash group participating flash.
- Press function button [ ] to set the flash mode of current group. TTL mode and M mode are supported.
- Press function button [ ] to switch groups, rotate [ ] to set flash exposure compensation and flash output of current group.

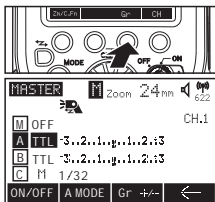

## 4. Group Focal Length Settings(ZOOM)

- Short press function button [ ] to enter into group focal length setting interface.
- Press function button [ ] to switch groups, press function button [ ] and [ ] or rotate [ ] to set focal length, and press [ ] to return.

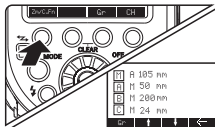

## 5. Test flash

When half press camera shutter button, the LINK light of master unit and slave unit lighting green. This means the communication is normal. Press [ ] button on master flash, the slave flash fires.

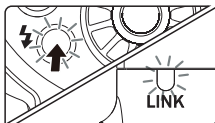

When you need bigger flash output, you can increase the slave unit.

## Wireless Flash Shooting: Radio Transmission

### 6. Wireless Slave Unit Setting -YN560 Mode

YONGNUO wireless flash trigger compatible with YN968N can be used as transmitter to fire YN968N. In radio wireless slave mode, YN968N can be switched between YN622 mode and YN560 mode. For the master unit setting, please refer to the master unit's user manual.

- Under MENU2 interface, press function button [ **YN560** ] to switch it to YN560 slave mode. Press function button [ **CH** ] to set channel of slave unit consistent with master unit. There are 1-16 channel for option.
- Press function button 3 [ **Gr** ] to set groups of slave unit. There are A/B/C/D/E/F groups optional.
- In YN560 mode, press [ **MODE** ] button to set flash mode. Supports M mode and Multi mode. Press function button [ **+/-** ] and rotate [  ] to set the flash output.

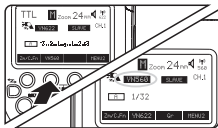

### Wireless Trigger Compatible List Supported by YN622 Mode

Transmitter (Speedlite)	YN968N Slave	Channel	Group Function	TTL Flash	Manual Flash	Zoom Setting
YN968N	YN622 Mode	CH1-CH7	Support A/B/C	Support	Support (Flash output can be adjusted from speedlite)	Support
YN622N-TX		CH1-CH7	Support A/B/C	Support	Support (Flash output can be adjusted from transmitter)	Support
YN622N(II)		CH1-CH7	Support A/B/C	Support	Support (Flash output can be adjusted from transmitter)	Do not support

### Wireless Trigger Compatible List Supported by YN560 Mode

Transmitter	YN968N Slave	Channel	Group Function	TTL Flash	Manual Flash	Zoom Setting
YN560-TX(II) Series	YN560 MODE	CH1-CH16	Support A/B/C/D/E/F	Do not support	Support (Flash output can be adjusted from YN560-TX)	Support
RF605 Series		CH1-CH16	Support A/B/C/D/E/F	Do not support	Support (need to set the flash out on the speedlite)	Do not support
RF603(II) Series		CH1-CH16	Do not Support (All groups can fire)	Do not support	Support (need to set the flash out on the speedlite)	Do not support

## Wireless Flash Shooting: Optical slave mode

Set the YN968N as optical slave unit.

- Press the button [  ] until displays the [  ] and [ SLAVE ].

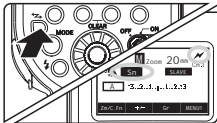

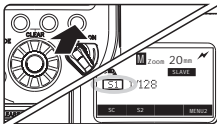

- Select a trigger mode when press the function button 4 [ MENU ] displays the SC/SN/SC&SN/S1/S2 trigger modes\*.

- Please allow the wireless trigger sensor face to the master flash by rotating the flash head. Before shooting, the slave unit and master unit should be set on the same channel.



SC/SN mode can respectively receive the built-in flash of the YN568EX II/580EXII/7D/60D/600D,SB-910/900/800/700, commander mode of Nikon camera, supports 4 channels, realizing TTL and manual flash.

Before shooting, the slave unit and master unit should be set on the same channel. S1 and S2 mode are suitable for MANUAL flash environment and TTL flash environment respectively. Under these two modes, the way to adjust the output is like that in M mode only by the function button [  ] and rotate the [  ].

SC: Indicating that it can only receive wireless signal from Canon system, avoiding Nikon system.

SN: Indicating that it can only receive wireless signal from Nikon system, avoiding Canon system.

SC&SN : Both support Canon & Nikon system.

S1 mode: In this mode it will work with the first flash synchronously of the master flash, with the result consistent with the use of radio slave. To use this mode properly, the master flash should be set at manual flash and the TTL flash system with preflight function and the red-reduction function with multiple flashes should not be used.

S2 mode: It is also called "pre-flash cancel mode". This mode is similar with S1 mode, but it can neglect the pre-flash given by TTL flash. Therefore, it can support the master flash working in TTL mode. In particular, if S1 mode cannot flash properly and synchronically with your internal flash, you can try to use S2 mode.

\*Commonly used trigger mode can be set by C.Fn-10 .

## Advanced Applications

### 1. Flash Exposure Compensation (FEC)

In order to make the shooting effect more suitable to your needs, you can set the flash exposure compensation through the camera or on the flash. The exposure compensation value is within the range of -3EV~+3EV. It can be set through pressing the function button [ +/- ] and rotating the [  ].

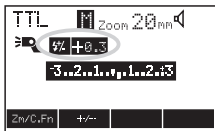

 NOTE: When the speedlite, camera and trigger have set the exposure compensation at the same time, which will overlap the exposure compensation.

### 2. Flash Exposure Bracketing (FEB)

The FEB function can be set through the camera. After the exposure bracketing being set, after every 3 photos being taken, exposure compensation will be made automatically, for example, exposure in the sequence of normal->under->over. This function helps you improve the success rate of shooting. The function need to operate on the camera, for the detailed operation method please refer to your camera manual.

 NOTE: When using the exposure bracketing, we suggest you set the driving mode of the camera as "single shot", and check if the flash back to full charger before shooting.

### 3. FV Lock

To use this function should be first set the [AE/AF-L] function button to "FV Lock" on the camera. At the moment please focus on the subject through the view window, and then press the [AE/AF-L] button. The speedlite will fire pre-flash to obtain the flash exposure degree of the subject. Then press the camera shutter when you confirm the shooting scene framework. (The function can only be used when it is supported by your camera. For the setting method please refer to your camera manual.)

### 4. High-speed Sync Flash

With high-speed sync (FP flash), the flash can be synchronized with all shutter speeds, the maximum shutter sync is up to 1/8000s. High-speed synchronization is particularly convenient to use aperture priority to fill flash for the portraits. Through the camera menu, set the flash sync speed to Auto FP, the speedlite will enable the high-speed sync function automatically.

### 5. Second-curtain Sync Flash

After the second-curtain sync enabled, the speedlite will flash at the moment when the shutter is going to be shut. Use the slow-speed shutter and second-curtain sync can make image tail for the shooting subject.

 The High-speed sync/second curtain sync flash function can only be used when it is supported by your camera. For the setting method please refer to your camera manual.

## Advanced Applications

### 6. Use Wide Panel

Pull out the Wide panel, push back the Reflection board and arrange them as per the figure; in such case, the flash scopes will extent to 14 mm ,the flash range will be enlarged and the effect will be softer and more natural.

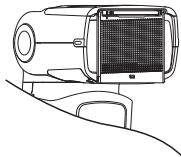

### 7. Reflection Flash

Bounce flash Means to take photos by making flash light head aimed at wall or ceiling and using the light reflected back from the ceiling or wall to light the desired object, so that the shade behind the object can be decreased to get more natural shooting effect.

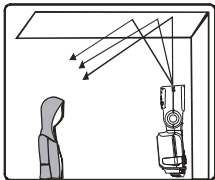

 If the wall or ceiling is too far, the bounce flash may be too weak to get enough exposure. The wall or ceiling should be even and white in order to get efficient reflection, if the reflection surface is not white, color cast may appear in photo.

### 8. Use Reflection Board

For shooting with the reflection board in flash, pull out the reflection board and the wide panel out from the light head at the same time and then push the wide panel back. In such case, if this product is being used to take photos, it will produce a highlighted point on the eyes of the subject and thus make the eyes charming (catching light). This function can reach optimal effect when the flash head is up 90°.

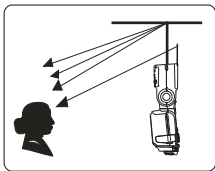

### 9. Using the diffuser(Options)

Fitting the diffuser lets you diffuse the light from the flash over a wide range, producing a softer light and reducing shadows.

When fitting the diffuser, the zoom position is locked, you can change the setting by P.Fn05.

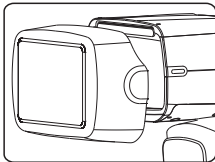

## Advanced Applications

### 10.Short Distance Flash Shooting

When you position the flash head down by  $7^{\circ}$ , you can shoot subjects at a short distance in a range of approx. 0.5 to 2 m.

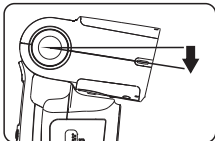

### 11.PC Sync port (input)

Through connecting to the PC sync port, you can make the flash synchronously.

### 12.Use the External Battery Pack

You can purchase the external battery pack SF-18C or SF-17C,connect it to the external power socket of the speedlite, even when using external power, insert batteries into the speedlite. After flash the battery pack will charge for the speedlite.

### 13.High-speed Continuous Shooting

The flash can support the high-speed continuous shooting function. Please set the camera in the continuous shooting form and then shoot.

### 14.Factory reset

Long press the function button 2 and button 3 can set the flash shooting function settings and wireless shooting setting recover to the default set-top TTL flash mode status. Clean the custom function settings(C.Fn) and personal function settings(P.Fn) please read the related chapter.

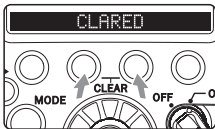

### 15.Firmware Upgrade

- 1).Log in the YONGNUO official website ([www.hkyongnuo.com](http://www.hkyongnuo.com)) to download the upgrade software and the latest firmware.
- 2).Power off, use USB-Micro USB cable connect to PC. (Do not include cable)
- 3).Press the [MODE] button and set the power switch to [ON], the LCD will display firmware upgrade interface.
- 4).Complete the firmware upgrade operation according to the prompt of software.

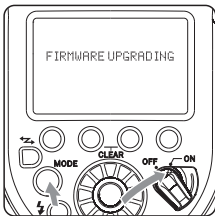

## C.Fn/P.Fn: Setting Custom /Personal Functions

Long press the function button [**Zn/C.Fn**] to enter into the custom function, rotating the [**⊙**] to choose the items which need adjusted. Then press the [**OK**] button to enter into the program setting mode, rotating the [**⊙**] to select the option and press [**OK**] button. After finishing the custom settings, press the function button [**←**] return to the ready shooting state. press the function button[P.FN]enter into the personal function , press the function button[Clear]to clear the C.FN or P.FN settings.

### C.Fn: Custom Functions

#### C.Fn-00: Firmware Version

Display the information of current version for the speedlite.



#### C.Fn-01: (Auto power off)

When the speedlite is not operated for 5 min., the power turns off automatically to save energy. You can disable this function.

0: ON (Enabled), 1: OFF (Disabled)

#### C.Fn-02: MODELING (Modeling flash)

0:  - Enabled Depth-of-field preview button

1:  /  - Enabled with both buttons

#### C.Fn-03: TEST (Test firing with autoflash)

0: 1/32 (1/32), 1: 1/1 (Full output)

#### C.Fn-04: AF ( AF-assist beam firing)

0: ON (Enabled), 1: OFF (Disabled)

#### C.Fn-05: (Auto zoom for sensor size)

0: FX (FX format), 1: DX (DX format)

#### C.Fn-06: (Slave auto power off timer)

0: 60min(60 minutes) , 1: 10min(10 minutes)

#### C.Fn-07: (Flash exposure metering setting)

0:  +  (Speedlite button and dial) , 1:  (Speedlite dial only)

#### C.Fn-08: (Beep)

0 : OFF ( Off ) , 1 : ON ( On )

## C.Fn/P.Fn: Setting Custom /Personal Functions

### C.Fn-09: (LCD panel illumination)

When a button or dial is operated, the LCD panel illuminates. You can change this illumination setting.

0: 12sec (On for 12 sec.)

1: OFF (Disable panel illumination)

2: ON (Illumination always on)

### C.Fn-10: Through the function button [MENU] can witch to the wireless optical slave mode.

0: SN (Only SN)

1: SC/SN (Including:SC/SN)

2: SN/S1/S2 (Including:SN/S1/S2)

3: SC/SNS1/S2 (Including:SC/SN/S1/S2)

### C.Fn-11: SL IND ( Slave unit indicator )

0:ON(Enabled)

1:OFF(Disabled)

## P.FN:Setting Personal Function

### P.Fn-01: ( LCD panel display contrast )

 P.Fn 01 You can adjust the contrast of the LCD panel in 5 levels.



### P.Fn-02: (LCD panel illumination color: Normal shooting)

0:GREEN(Green) , 1:ORANGE ( Orange )

### P.Fn-03: ( LCD panel illumination color: Master)

0:GREEN(Green) , 1:ORANGE ( Orange )

### P.Fn-04: (LCD panel illumination color: Slave)

0:GREEN(Green) , 1:ORANGE ( Orange )

### P.Fn-05: (Diffuser auto detection )

0:AUTO, 1:OFF

### P.Fn-06: (Wireless button toggle sequence)

0:OFF-->-->

1:OFF<-->

2:OFF<-->

## Shooting with LED Light

### Using the LED light

1. Make the flash unit vertical ( 90°upward bounce )
2. Press the [LED]button , the LED comes on, the LED lighting on the LCD panel.
3. Rotate the [⊙]to adjust the brightness.
4. Press the [LED] button again or press the function button[ ← ]to turning off the LED light.

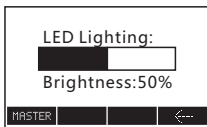
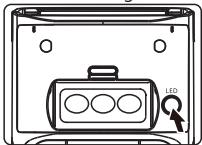

### Using the LED light with radio wireless master

When shoot with LED light, press the function button [MASTER] to keep shooting with LED light and use(the master flash is disable).

### Using the built-in diffuser

Using a built-in diffuser reduces glare and softens light. It can also unnatural multiple shadows.

Firmly pull the handle of the built-in diffuser down to the bottom of the window and attach it. when storing, pull the handle up into the main body.

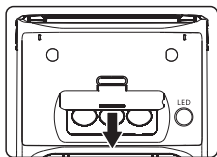

### Using the color conversion filter

Using a color conversion filter lets you change the color temperature to about 3200K(at maximum brightness)

Align the clips on each side of the color conversion filter with the rim of the LED light and press the color conversion filter on.

To remove the color conversion filter, hold the protrusions on each side and pull it off.

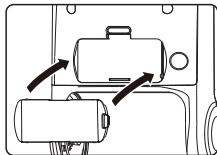

- The flash cannot fire when the LED light is on.
- The color temperature varies slightly with brightness adjustments and LED temperature, so check the white balance before recording.
- Using this flash unit when the subject is too close to the camera may create multiple shadows of the subject.
- The LED light goes off when the flash head is directed horizontal or downward.

## Troubleshooting

### 1. Power does not turn on or the flash does not fire.

- Make sure that the batteries are installed in the correct orientation.
- Please check if the speedlite is in overheat protection status.
- If the electrical contacts of the speedlite and camera are dirty, clean the contacts.

### 2. The flash automatically shut off the power.

Please check if the flash enable the power saving mode or whether the battery power is enough.

### 3. Photos are under exposure or over exposure.

Check if the set shutter, aperture and ISO are too near the flash limit or if some settings including exposure compensation in relation to flash are proper.



### 4. Vignetting appears in photos or only part of the subject is illuminated.

Please check the current coverage of focal length and make sure if the lens focal length exceeds the coverage range of the flash. The product's zooming range is 20~105 mm of the medium format system. You can try to pull out the wide-angle diffuser to expand the flash range.

### 5. Wireless slave unit doesn't fire.

Please check if the mode (YN622 or YN560 mode) of wireless master unit and slave unit are set the same. Different mode setting will lead to abnormal communication. Please set the channel of wireless master unit same as the slave unit, and make sure the wireless slave unit is located in the effective transmission range.

### 6. The optical slave unit does not fire.

Set the master unit to [  ] and [ MASTER ] (about the master unit please refer to the master unit's user manual) and set the slave unit to [  ] and [ SLAVE ]. Set the transmission channel and of the master unit and slave unit to the same numbers. Check that the slave unit is within the transmission range of the master unit.

### 7. Can not test flash or master flash does not fire.

- Please check if the LED light is ON.
- Please press function button [ ON/OFF ] to check if the master unit is set as disabled.

### 8. Other problems.

Try to clear the settings of flash and camera, try to disable the flash power source and then restart the flash.

## Specifications

Circuit design:	Insulated Gate Bipolar Transistor (IGBT)
Guide No.:	60 (ISO 100,105mm)
Flash mode:	TTL, M, Multi
Trigger mode:	Set-top mode, radio wireless master mode, radio wireless slave mode, wireless optical slave mode (SC,SN,SC&SN,S1,S2)
Zoom :	Auto,20,24,28,35,50,70,80,105
Vertical rotation angle:	-7~150 degrees
Horizontal rotation angle:	0~360 degrees
Power supply:	4xAAsize batteries (Alkaline or Ni-MH are usable)
Lighting times:	100~1500 times (AA alkaline cell used)
Recycle time:	Approx 3s (AA alkaline cell used)
Flash color temperature:	5600k
Flash time:	1/200s~1/20000s
Flash control:	8 levels of output control (1/128~1/1), 29 levels of fine tuning
External interface:	Hot shoe, PC port
LED Color temperature:	Apporx. 5500K
LED luminance:	Apporx. 300lux(1m)
Optical transmission triggering distance:	20~25m indoor, 10~15m out door
Radio transmission triggering distance:	Up to 100m
Additional features:	Master flash, high-speed sync, second-curtain sync, FEC, FEB, FVL, the electronic flash head zooming, sound prompt, automatically saving setting, PC port, power saving mode, overheat protection, custom functions (C.Fn), personal functions(P.Fn).
Dimensions:	78×60.5×206mm(extended state)
Net weight:	435g
Contains items:	Speedlite(1) , protecting bag(1) , mini stand (1) , color conversion filter for LED light(1) , usermanual ( 1 )

The functions of this user manual are based on test conditions of our company. Further notice will not be given if the design and specifications change.

The YONGNUO logo in this manual includes the registered trademark or trademark of Shenzhen Yongnuo Photography Equipment Co., Ltd in China or/and other countries(regions). All other trademarks are the property of their respective owners.

## 深圳市永诺摄影器材股份有限公司

深圳市福田区华强北路赛格科技园2栋5楼B509室

TEL:(086) 0755-8376 2448 Email: [service@hkyongnuo.com](mailto:service@hkyongnuo.com)

FAX:(086) 0755-8376 2768 Website: [www.hkyongnuo.com](http://www.hkyongnuo.com)

全国服务电话：400-001-3888