

YONGNUO
DIGITAL

TTL闪光灯

SPEEDLITE
YN968EX-RT

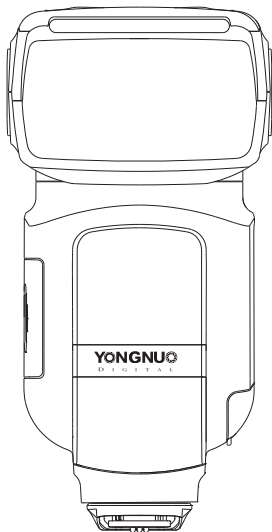

使用说明书
INSTRUCTION MANUAL

在使用本产品之前，请通读本手册，以确保您能正确、安全使用，然后保存好本手册以便将来查询参考。

Before use, please read this user manual carefully in order to ensure your safety. Keep it properly for reference in the future.

Contents

Precaution	1
Features	2
Quick Start.	3
Components Description.	4
LCD Panel	5-6
Installation Instruction.	7
Basic Operations	8-11
Wireless Flash Shooting	12-15
Advanced Applications	16-19
C.Fn/P.Fn: Setting Custom /Personal Functions	20-21
Shooting with LED Light	22
Troubleshooting	23
Specifications	24

Precaution

- To avoid fire or electrical shock, do not expose this product to rain or moisture.
- To avoid short circuit, please make sure the batteries contacts are securely packed and use the battery in accordance with the local provisions.
- Please place the batteries and the parts which can be swallowed mistakenly away from children. If swallowed, please get medical help immediately.
- To avoid any possible injury to eyes, do not use the flash in a short distance from the eyes.
- To avoid any possible safety accident, do not use the flash on the people focusing attention.
- Please take out the batteries and stop using this product immediately in case of the following situation:
- This product is dropped or shocked seriously and the inner part of this product is bared.
- Wear gloves and take the batteries out if the corrosive liquid inside the batteries leaks.
- This product gives off strange smell, heat or smokes.
- Do not disassemble or maintain this product because the internal high voltage circuit may cause the electric shock.
- Please take out all the batteries if this product is not used for a long time.

Features

- **Equipped with LED Light**

Equipped with a high power LED light of high power, brightness can be adjusted, there is a built -in diffuser and a color conversion filter for the LED light.

- **Fully Compatible with YONGNUO YN-E3-RT/YN600EX-RT, Canon' s 600EX-RT/ST-E3-RT Wireless Signal**

One YN968EX-RT can be used as master unit to trigger YONGNUO YN600EX-RT,Canon 600EX-RT,and live display the flash groupings of slave unit and recycling information, one YN968EX-RT can respectively receive the wireless signal of master unit YN600EX-RT,YN-E3-RT,Canon' s 600EX-RT/ST-E3-RT, realizing remote TTL\M \Multi\Gr flash, supports linked shooting with radio transmission.

- **High Guide Number, Supports High-speed Sync**

GN60@ISO100,105mm, supports high-speed sync TTL, manual flash, multi flash, Gr grouping flash, the highest synchronous speed can reach 1/8000S

- **Support Auto/Manual Zooming**

The YN968EX-RT supports auto and manual zooming, the flash coverage can be changed between AUTO, 20~105mm.

- **Supports USB Firmware Upgrade**

The YN968EX-RT equipped with the USB interface, supports firmware upgrade, the users can download the upgrade firmware through the Yongnuo official website to upgrade the flash.

- **Supports Wireless Optical Slave function**

The YN968EX-RT supports receiving YONGNUO, Canon' s and Nikon' s wireless optical master signal, supports S1 and S2 flash mode.





- **Settings Save Automatically, Supports Custom Functions (C.Fn), Personal Functions(P.Fn).**

- **Ultrafast Charging Recycle System, Supports External Power Supply**

- **Equipped with Big Size LCD Display Screen, Standard PC Synchronous Interface**

Quick Start

If you don't have much time to read the whole user manual, we advise you to read this section.

1. Please avoid the excessive use of the output with maximum power. It can effectively extend the service life of this product. (It is recommended that the speedlite should be idle for more than 3 minutes when entering the overheat protection).
2. Short press the function button [] and [MODE] button can switch the trigger mode and flash mode (Gr flash mode only in wireless master mode).
3. When used as master unit, through the function [RATIO] button can set the participated exposure flash group.
4. Short press the function button [] can enter into the focal length setting state. long press the function button [] can enter into the advanced options setting state, then through the [] and [OK] buttons can set the coverage of the focal length and the custom function/personal functions.
5. Function button 1-4 corresponding to different functions according to current state of the flash, operations and details please refer to the following chapters.
6. Long press the function button 2 and button 3 can set the flash shooting function settings and wireless shooting setting recover to the default set-top TTL flash mode status.
7. Make the flash unit vertical, press the LED button, the LED comes on, the LED lighting on the LCD panel, press the LED button again turning off the LED light.
8. When you position the flash head down by 7° , you can shoot subjects at a short distance in a range of approx. 0.5 to 2 m.

Components Description

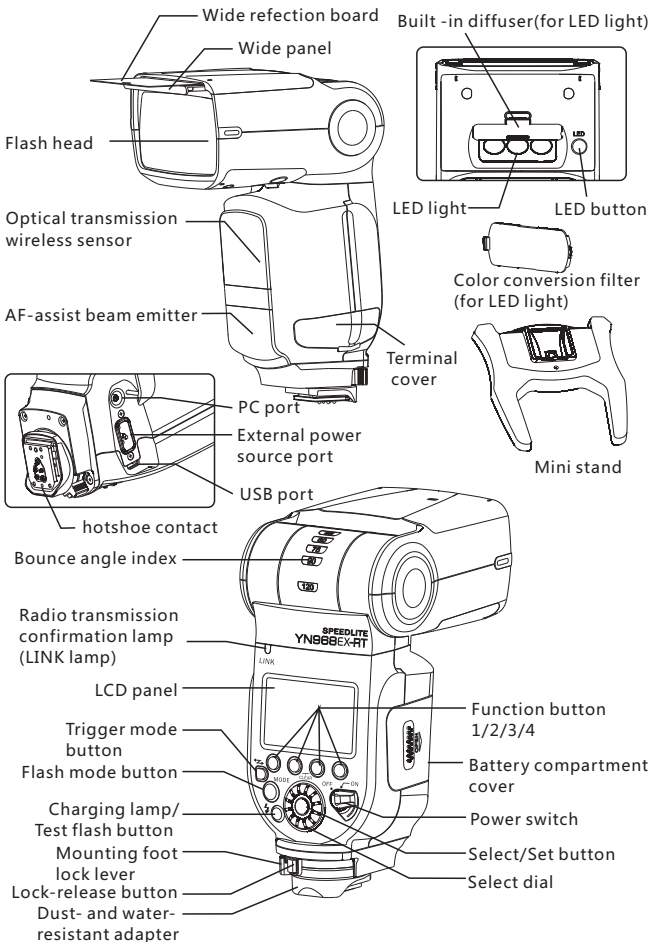

LCD Panel

ETTL flash

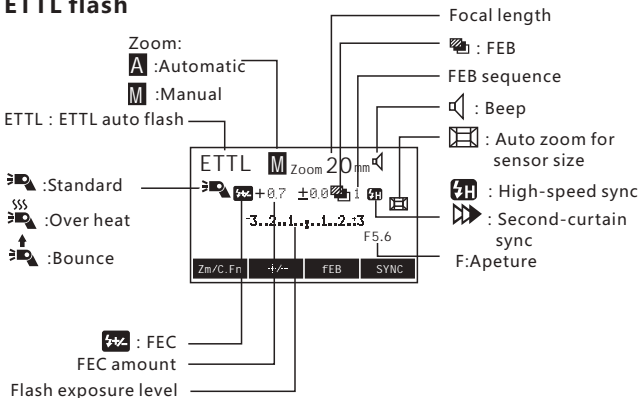

Manual flash

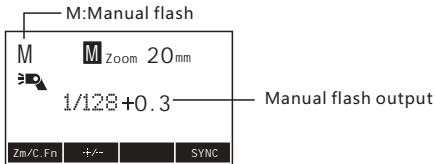

Multi(stroboscopic) flash

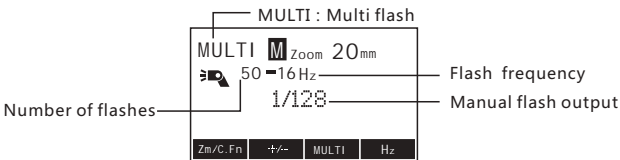

LCD Panel

Short press the button  can switch the trigger mode: set top, radio wireless master mode, radio wireless slave mode, optical wireless slave mode(include SC/SN/SC&SN/S1/S2)

 :Set on flash



 :Master flash firing ON

 :Master flash firing OFF

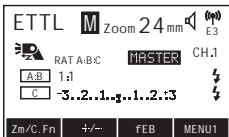

 : Radio transmission wireless shooting

MASTER : Master

 : Slave flash ready (radio transmission)

 :Slave icon



 : Radio transmission wireless shooting

SLAVE : Slave

 :Slave icon

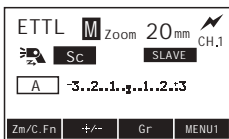

 : Optical transmission wireless shooting

SLAVE : Slave

Installation Instruction

1. Install Batteries

Slide the battery compartment cover in the direction of the arrow as shown. Insert the batteries according to the label inside battery compartment and make sure the direction of the battery contact (+/-) is correct. Close the battery compartment cover in the direction of the arrow as shown.

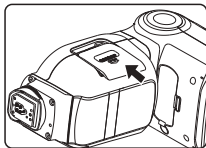
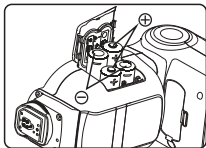
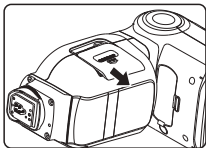

⚠ WARNING: LiFePO4 and/or Li-ion type batteries ARE NOT COMPATIBLE, PLEASE USE alkaline or NiMH type batteries! To avoid circuit, please do not use damaged batteries.

2. Attaching to the Camera & Detaching from the Camera

Slip the speedlite's mounting foot all the way into the camera's hot shoe. Slide the mounting foot lock lever to the right side as the arrow shown, until heard the "clicks" sound.

To detach the speedlite, press the [lock-release button] and slide the [Mounting foot lock lever] to the left side, then detach the speedlite.

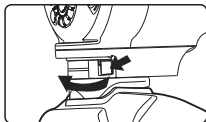
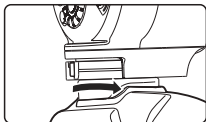
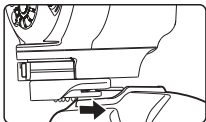

3. Power-on and Power-off

Set the power switch to [ON] position, the speedlite will turn on and start charging.

After turned on, the [Charging lamp] will bright with red light which indicates it can flash. After use, set the switch to [OFF] position to turn off the power source. Please take out the batteries after turning off the power of the speedlite.

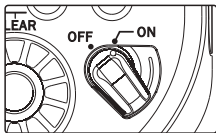

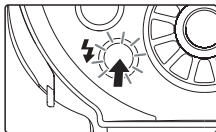

4. Test Flash

When the charging lamp turns red, you can test the flash is normal or through the [TEST] button.



Basic Operations

1.Button Operation

[ON/OFF]switch	Set the switch to the ON/OFF can turn on/off the power source
[MODE]button	Through the button can switch between E TTL/M/MULTI/Gr (Gr mode only in wireless master mode)
[]Trigger mode button	Short press the button can switch the trigger mode: set top,radio wireless master , radio wireless slave, optical wireless slave(SC/SN/SC&SN/S1/S2)
[]Select dial	Through the dial can adjust the selected parameters which need adjusted, related operations and details please refer to the subsequent chapters
[]Select/OK button	Confirm and save the parameter settings
[Function button 1/2/3/4]	According to the current state of the flash, the corresponding four function buttons are in different roles, related operations and details please refer to the subsequent chapters
[TEST] button	Test flash

2.States of [Charging Indicator]

States	Meaning	Method
Red light	The speedlite is fully charged and can be used.	Normal
Green light	Quick flash* ready	The speedlite can be used with "quick flash"
Goes off	The speedlite has not been fully charged.	Waiting for completion of fully charged.

*About Quick Flash

The Quick Flash function enables flash shooting while the charging lamp is green (before the flash is fully charged).The guide number is 1/2 to 1/6 of the full output, but it is useful for shooting with a faster recycling time at a short shooting distance.

Basic Operations

3. Meaning of [Link lamp]

[LINK] lamp statuses	Meaning	Method
Green light	Transmission OK.	Normal
Red light	Not connect.	Check if the channel and ID of the master unit and slave unit are consistent.
Orange	Used as the second and the subsequent master unit	Normal

4. The meaning of [Sound Prompt]

The Sound Form	Meaning	Method
Tick-a short sound	Wireless transmission OK	Normal
Tick---a long sound	The speedlite is fully charged, and can be used.	Normal
Three tick, two times	The exposure maybe excessive.	Adjust exposure compensation or change shooting condition.
Tick tick tick	The exposure may be insufficient	Adjust exposure compensation or change shooting condition.
Tick-tick tick tick tick	Overheat protection prompt	Waiting for completion of charging, idle 3-5 minutes for overheat released.
Tick-tick-tick	Low battery and the speedlite is about to shut down.	Replace the batteries.

Basic Operations

5. E TTL Mode

In E TTL mode, the metering system of this camera will detect flash illumination reflected back from the object so as to automatically adjust the exposure compensation.

In E TTL mode, the light intensity can be adjusted by setting FEB, FEC and flash exposure lock(FEL).

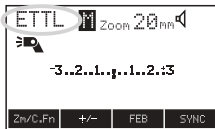

6. M Mode

In M mode, you can set flash output as your requirement by short press the function button [+/-], when the [Flash output level] displays on the screen, you can adjust the flash output through []. Adjustment range of flash output is 1/128-1/1, and the output can be divided into 8 grades, each has maximum 3 grades for fine adjustment, with grade 0.3EV, 0.7EV as adjustment increment, totally 29 grade fine adjustment.



7. Multi (stroboscopic) Mode

Multi mode, the speedlite will flash according to the flash output, flash frequency and number of flashes you set. Select the number of flashes through the function button [MULTI], select the frequency through the function button [Hz]. Then adjust the numbers of flashes and flash frequency through the []. The adjustment method of the flash output are same as the M mode. The number of flashes range is 1-100, and the range of flash frequency is 1-199.

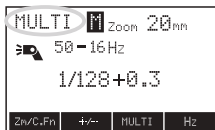

8. Gr Mode(Wireless master mode only)

When the YN968EX-RT set to wireless master mode, through the [MODE] button can set the flash mode as Gr mode. In the Gr mode, supports triggering up to A/B/C/D/E five groups of flashes (Up to 15 slave flashes), and can set different flash mode and flash output for each group.

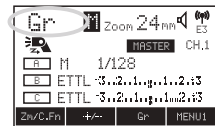

9. Menu Access of Camera

When this speed-lite is used with Canon EOS digital camera released since 2007, flash function and custom function can be set from camera menu. For the operation please refer to the user manual of the camera.



Basic Operations

10.Auto zoom :

Short press the function button [Zm/C.Fn] until the local length value displays on LCD panel, then adjust the coverage through [Z]. When it displays [A], attach the speedlite to the camera, the flash coverage will change as the lens focal length and move back and forth to accommodate different flash coverage .

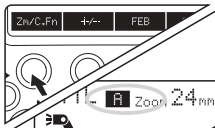

11.Manually set the zooming position:

Press the function button [Zm/C.Fn] until the local length value displays on LCD panel, then adjust the coverage through [Z].

If [M] is displayed, you can adjust the flash coverage (20,24,28,35,50,70,80,105mm) manually.

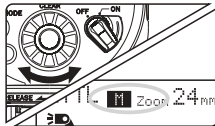

12.AF Assist Beam Emitter

When using AF under low-light, the built-in AF-assist beam emitter of the speedlite will be emitted automatically to make it easier to autofocus.

13. Automatic Setting Saving

The speedlite will automatically save the current settings which will be convenient to your next use.

14. Power Saving Mode

The power saving mode can be achieved by through custom functions settings, please refer to the C.Fn chapters.

15.Overheat protection

When continuous flash, the temperature of the flash head may increase, a warning icon [] icon will be displayed on LCD panel, and the recycling time will be longer.

When repeated firings of the flash, the overheat protection function will be triggered, the LCD is lighting in red, the speedlite will be locked ,in such case, please wait for about 3 to 5 minutes before continuing use.



- When the speedlite warns overheat, please reduce the use intensity.
- Please mind the hot batteries when you take them out after the continuous shooting.

Wireless Flash Shooting: Radio Transmission

Press the function button [] to set the master flash firing on or off. Press the function button [] to set the firing group. Press the function button [] and rotate the [] can adjust the exposure compensation (or flash output).

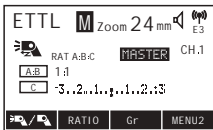

About Master Units

You can use two or more master units (master units + slave units = maximum of 16 units). By preparing multiple cameras with master units attached, you can shoot by changing cameras while keeping the same lighting (slave units).

Note that when using two or more master units, the color of the [LINK] lamp varies depending on the order in which the power was turned on. The first master (main master) is green and the second and subsequent masters (sub-masters) are orange.

Wireless slave unit setting

Short press the button [] to switch the trigger mode, until the [] and [] are displayed. Set the channel and ID (Same as setting the master unit, please set the channel and ID of the slave unit consistent with the master unit's.)



Short press function button 3 [] to set the groups of the slave units. There is five groups (A/B/C/D/E) for selection.

Press function button 2 [] and rotate the [] to set the exposure compensation. If the exposure compensation is set in the master unit, the actual FEC value superimposed.

Advanced Function of Slave Unit



Press the function button [] to release the camera shutter of the master unit and fire. This function applies to the newer cameras only.

Press the function button [], each speedlite emit the modeling flash.

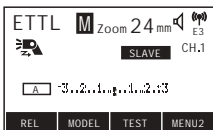
Press the function button [] to test the flash from the master unit and slave unit.



Wireless Flash Shooting: Optical slave mode

Short press the button [] until displays the [] and [SLAVE]. Select a trigger mode when press the function button 4 [MENU] displays the SC/SN/SC&SN/S1/S2 trigger modes*. Please allow the wireless trigger sensor face to the master flash by rotating the flash head. Before shooting, the slave unit and master unit should be set on the same channel.

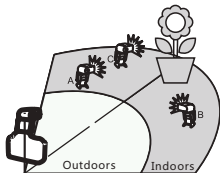

SC/SN mode can respectively receive the built-in flash of the YN568EX II/580EXII/7D/60D/600D, SB-910/900/800/700, commander mode of Nikon camera, supports 4 channels, realizing TTL and manual flash.

Before shooting, the slave unit and master unit should be set on the same channel. S1 and S2 mode are suitable for MANUAL flash environment and TTL flash environment respectively. Under these two modes, the way to adjust the output is like that in M mode only by the function button [+/-] and rotate the [].

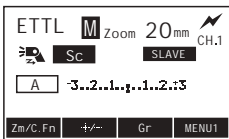

SC: Indicating that it can only receive wireless signal from Canon system, avoiding Nikon system.

SN: Indicating that it can only receive wireless signal from Nikon system, avoiding Canon system.

SC&SN : Both support Canon & Nikon system.

S1 mode: In this mode it will work with the first flash synchronously of the master flash, with the result consistent with the use of radio slave. To use this mode properly, the master flash should be set at manual flash and the TTL flash system with preflight function and the red-reduction function with multiple flashes should not be used.

S2 mode: It is also called "pre-flash cancel mode". This mode is similar with S1 mode, but it can neglect the pre-flash given by TTL flash. Therefore, it can support the master flash working in TTL mode. In particular, if S1 mode cannot flash properly and synchronically with your internal flash, you can try to use S2 mode.

*Commonly used trigger mode can be set by C.Fn-25 .

Wireless Flash Shooting

Wireless Multi Flash Shooting

In wireless flash shooting you can create 1~5(up to three groups: A/B/C in wireless shooting optical transmission) slave unit groups to achieve multi-faceted flashing, and the master unit set up the flash ratio of TTL auto flash shooting ,flash output, multi flash or Gr mixed mode flash.

When the master unit set to ALL, the slave unit set to A/B/C group will fire in the same mode and same flash output; when the master unit set to <A:B>, only set to A and B group the slave unit can be triggered; when the master unit set to <A:B C>, only set to A,B,C group the slave unit can be triggered; If you want to set the A,B,C,D,E group of slave unit can be triggered by the master unit, please set the flash mode of master unit to Gr mode(The Gr mode can only be selected in the wireless radio transmission shooting)

Slave Group Control

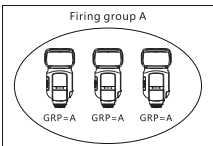

If you need more flash output or wish to perform more sophisticated lighting, you can increase the number of slave units.

Simply set an additional slave unit to the firing group (A, B or C) whose flash output you want to increase. You can increase the number of slave units up to 15 units in total(in radio transmission).

For example, if you set a firing group with three slave units to <A>,the three units are control led as a single firing group A with a large flash output.

Advanced Applications

1. Flash Exposure Compensation(FEC)

In order to make the shooting effect more suitable to your needs, you can set the flash exposure compensation through the camera or on the flash. The exposure compensation value is within the range of -3EV~+3EV. It can be set through pressing the function button [+/-] and rotating the [].

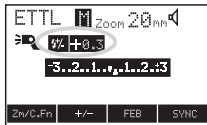

 NOTE: Please note that this compensation setting will overlap the exposure compensation setting on the camera. When used as the slave unit, the exposure compensation value set on the slave unit will overlap the exposure compensation on the master unit.

2. Flash Exposure Bracketing (FEB)

The FEB function can be set through the camera or speedlite. After the FEB is set, after every 3 photos are taken, exposure compensation will be made automatically in the sequence of. for example, normal->under->over. This function helps you improve the success rate of photo taking. Please short press the function button [FEB] and [] to directly adjust the exposure bracketing value.

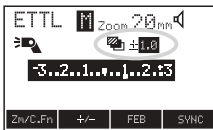

 NOTE: For FEB, set the drive mode of camera to "single shooting", be sure the flash is ready before shooting.

3. FE Lock(FEL)

To use this function, cover the subject for which flash exposure will be locked at the center of the viewfinder of camera, press the button [*] of the flash exposure lock, and the flash light will pre-flash and the camera will calculate the appropriate flash output data. Now you have some time for recomposition, after it you can take photo. (The function can only be used when it is supported by your camera. For the setting method please refer to your camera manual.)

4. High-speed Sync Flash

With high-speed sync (FP flash), the YN968EX-RT can be synchronized with all shutter speeds, it is particularly convenient to use aperture priority to fill flash portraits, the maximum shutter sync is up to 1/8000. Press the function button [SYNC] button to turn on or off the high-speed synchronization function.

5. Rear-curtain Sync Flash

You can use slow-speed shutter to produce trailing smear for the object and the flash light will flash at the moment when the shutter is going to be shut, which means the rear-curtain sync function (refer to camera' s manual for setting). You can turn on or off the rear-curtain sync by pressing the function button [SYNC] on the speedlite.

 When the YN968EX-RT is used as wireless flash, the rear-curtain sync function cannot be set.

Advanced Applications

6. Use Wide Panel

Pull out the Wide panel, push back the Reflection board and arrange them as per the figure; in such case, the flash scopes will extent to 14 mm ,the flash range will be enlarged and the effect will be softer and more natural.

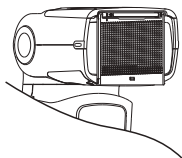

7. Reflection Flash

Bounce flash Means to take photos by making flash light head aimed at wall or ceiling and using the light reflected back from the ceiling or wall to light the desired object, so that the shade behind the object can be decreased to get more natural shooting effect.

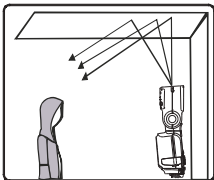

 If the wall or ceiling is too far, the bounce flash may be too weak to get enough exposure. The wall or ceiling should be even and white in order to get efficient reflection, if the reflection surface is not white, color cast may appear in photo.

8. Use Reflection Board

For shooting with the reflection board in flash, pull out the reflection board and the wide panel out from the light head at the same time and then push the wide panel back. In such case, if this product is being used to take photos, it will produce a highlighted point on the eyes of the subject and thus make the eyes charming (catching light). This function can reach optimal effect when the flash head is up 90°.

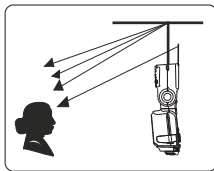

9. Using the diffuser(Options)

Fitting the diffuser lets you diffuse the light from the flash over a wide range, producing a softer light and reducing shadows.

When fitting the diffuser, the zoom position is locked, you can change the setting by P.FN04.

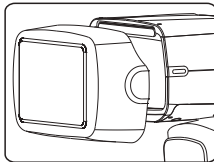

Advanced Applications

10.Short Distance Flash Shooting

When you position the flash head down by 7° , you can shoot subjects at a short distance in a range of approx. 0.5 to 2 m.

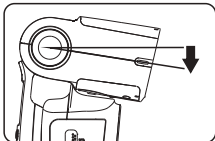

11.PC Sync port (input)

Through connecting to the PC sync port, you can make the flash synchronously.

12.Use the External Battery Pack

You can purchase the external battery pack SF-18C or SF-17C,connect it to the external power socket of the speedlite, even when using external power, insert batteries into the speedlite. After flash the battery pack will charge for the speedlite.

13.High-speed Continuous Shooting

The flash can support the high-speed continuous shooting function. Please set the camera in the continuous shooting form and then shoot.

14.Factory reset

Long press the function button 2 and button 3 can set the flash shooting function settings and wireless shooting setting recover to the default set-top TTL flash mode status. Clean the custom function settings(C.Fn) and personal function settings(P.Fn) please read the related chapter(P20).

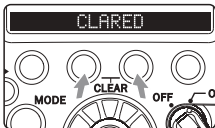

15.Firmware Upgrade

- 1).Log in the YONGNUO official website (www.hkyongnuo.com) to download the upgrade software and the latest firmware.
- 2).Power off, use USB-Micro USB cable connect to PC. (Do not include cable)
- 3).Press the **[MODE]** button and set the power switch to **[ON]**, the LCD will display firmware upgrade interface.
- 4).Complete the firmware upgrade operation

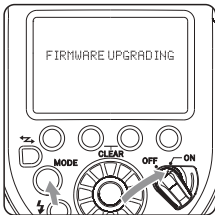

Advanced Applications

16. Linked shooting with radio transmission*

Linked shooting is a function that automatically releases the shutter of a slave unit camera by linking it to a master unit camera. You can shoot with linked shooting for up to 16 units, including both master units and slave units. This is convenient when you want to shoot a subject from multiple angles at the same time.

To shoot with linked shooting, attach a flash (such as YN968EX-RT) that supports the linked shot function or the speedlite transmitter (such as YN-E3-RT) to the camera.

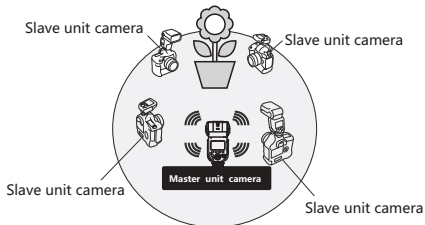
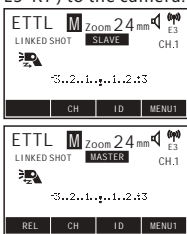

*This function is only for the EOS digital cameras (such as EOS-1D X) released after 2012, it does not need the shutter release cable.

1). Set to linked shooting mode. (only set on mode)

Long press the [] button continuously until [LINKED SHOT] is displayed on the LCD panel. Linked shooting mode's "Slave unit" is set.

Press the [] button again to set "Master unit" of the linked shooting mode.

2). Set the channel and ID.

3). Set the camera's shooting functions.

4). Set all the transmitters or flash.

Repeat steps 1 to 3 and set all the transmitters or flashes to "Master unit" or "Slave unit" in the linked shooting mode.

When pressing the [] button to change the setting of a unit from "Slave unit" to "Master unit," the other transmitters (or Speedlites) that were set to "Master unit" until then automatically switch to "Slave unit".

5). Set up the slave unit cameras.

Check that the [LINK] lamp of the slave unit is lit in green.

6). Take the picture.

Check that the [LINK] lamp of the master unit is lit in green and take the picture.

The slave unit cameras are released in coordination with the master unit camera.

After shooting with linked shooting, the [LINK] lamp of the slave unit is briefly lit in orange.

C.Fn/P.Fn: Setting Custom /Personal Functions

Long press the function button [**Zn/C.Fn**] to enter into the custom function, rotating the [**⊙**] to choose the items which need adjusted. Then press the [OK] button to enter into the program setting mode, rotating the [**⊙**] to select the option and press [OK] button. After finishing the custom settings, press the function button [**←**] return to the ready shooting state. press the function button[P.FN]enter into the personal function , press the function button[Clear]to clear the C.FN or P.FN settings.

C.Fn: Custom Functions

C.Fn-00: Firmware Version

Display the information of current version for the speedlite.

C.Fn-01: (Auto power off)

When the speedlite is not operated for 5 min., the power turns off automatically to save energy. You can disable this function.

0: ON (Enabled), 1: OFF (Disabled)

C.Fn-02: MODELING (Modeling flash)

0:  -Enabled Depth-of-field preview button

1:  -Enabled Test firing button

2:  - Enabled with both buttons

3: OFF-Disabled)

C.Fn-03: AUTO CANCEL (FEB auto cancel)

0: ON (Enabled), 1: OFF (Disabled)

C.Fn-04: (FEB sequence)

0: 0 / - / + , 1: - / 0 / +

C.Fn-07: TEST (Test firing with autoflash)

0: 1/32 (1/32), 1: 1/1 (Full output)

C.Fn-08: AF (AF-assist beam firing)

0: ON (Enabled), 1: OFF (Disabled)

C.Fn-09: (Auto zoom for sensor size)

0: ON (Enabled) , 1: OFF (Disabled)

C.Fn-10: (Slave auto power off timer)

0: 60min(60 minutes) , 1: 10min(10 minutes)

C.Fn-13: (Flash exposure metering setting)

0:  +  (Speedlite button and dial) , 1:  (Speedlite dial only)

C.Fn/P.Fn: Setting Custom /Personal Functions

C.Fn-22: (LCD panel illumination)

When a button or dial is operated, the LCD panel illuminates. You can change this illumination setting.



0: 12sec (On for 12 sec.)

1: OFF (Disable panel illumination)

2: ON (Illumination always on)

C.Fn-23: (Slave flash battery check)

0:  /  (AF-assist beam,  lamp)

1:  ( lamp)

C.Fn-25: Through the function button [MENU] can witch to the wireless optical slave mode.

0: SC (Only SC)

1: SC/SN (Including:SC/SN)

2: SC/S1/S2 (Including:SC/S1/S2)

3: SC/SNS1/S2 (Including:SC/SN/S1/S2)

C.Fn-26: SL IND (Slave unit indicator)

0:ON(Enabled)

1:OFF(Disabled)

P.FN:Setting Personal Function

P.Fn-01: (LCD panel illumination color: Normal shooting)

0:GREEN(Green) , 1:ORANGE (Orange)

P.Fn-02: (LCD panel illumination color: Master)

0:GREEN(Green) , 1:ORANGE (Orange)

P.Fn-03: (LCD panel illumination color: Slave)

0:GREEN(Green) , 1:ORANGE (Orange)

P.Fn-04: (Diffuser auto detection)

0:AUTO, 1:OFF

P.Fn-05: (Wireless button toggle sequence)

0:OFF--> -->

1:OFF<-->

2:OFF<-->

P.Fn-06: LINKED SHOT (LINKED SHOT)

0:OFF , 1:ON

Shooting with LED Light

Using the LED light

1. Make the flash unit vertical (90°upward bounce)
2. Press the [LED] button , the LED comes on, the LED lighting on the LCD panel.
3. Rotate the [] to adjust the brightness.
4. Press the [LED] button again or press the function button [←] to turning off the LED light.

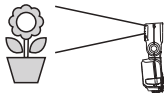
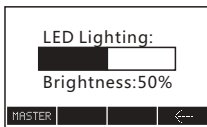
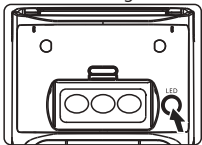

Using the LED light with radio wireless master

When shoot with LED light, press the function button [MASTER] to keep shooting with LED light and use(the master flash is disable).

Using the built-in diffuser

Using a built-in diffuser reduces glare and softens light. It can also unnatural multiple shadows.

Firmly pull the handle of the built-in diffuser down to the bottom of the window and attach it. when storing, pull the handle up into the main body.

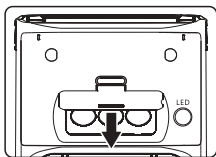

Using the color conversion filter

Using a color conversion filter lets you change the color temperature to about 3200K(at maximum brightness)

Align the clips on each side of the color conversion filter with the rim of the LED light and press the color conversion filter on.

To remove the color conversion filter, hold the protrusions on each side and pull it off.

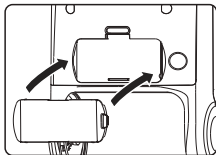

- The flash cannot fire when the LED light is on.
- The color temperature varies slightly with brightness adjustments and LED temperature, so check the white balance before recording.
- Using this flash unit when the subject is too close to the camera may create multiple shadows of the subject.
- The LED light goes off when the flash head is directed horizontal or downward.

Troubleshooting

1. Power does not turn on or the flash does not fire.

- Make sure that the batteries are installed in the correct orientation.
- Please check if the speedlite is in overheat protection status.
- If the electrical contacts of the speedlite and camera are dirty, clean the contacts.

2. The flash automatically shut off the power

Please check if the flash enable the power saving mode or whether the battery power is enough.



3. Photos are under exposure or over exposure?

Check if the set shutter, aperture and ISO are too near the flash limit or if some settings including exposure compensation in relation to flash are proper.



4. Vignetting appears in photos or only part of the subject is illuminated?

Please check the current coverage of focal length and make sure if the lens focal length exceeds the coverage range of the flash. The product's zooming range is 20~105 mm of the medium format system. You can try to pull out the wide-angle diffuser to expand the flash range.

5. The radio slave unit does not fire.

Set the master unit to [] and [MASTER], set the slave unit to [] and [SLAVE]. Set the transmission channel and radio IDs of the master unit and slave unit to the same numbers. Check that the slave unit is within the transmission range of the master unit.

6. The optical slave unit does not fire.

Set the master unit to [] and [MASTER] (about the master unit please refer to the master unit's usermanual) and set the slave unit to [] and [SLAVE]. Set the transmission channel and of the master unit and slave unit to the same numbers. Check that the slave unit is within the transmission range of the master unit.

7. Can not test flash or master flash does not fire.

- Please check if the LED light is ON.
- Please press function button [] to check if the master unit is set as disabled.

8. Other problems

Try to clear the settings of flash and camera, try to disable the flash power source and then restart the flash.

Specifications

Circuit design:	Insulated Gate Bipolar Transistor (IGBT)
Guide No.:	60 (ISO 100,105mm)
Flash mode:	TTL,M, Multi,Gr
Trigger mode:	Set-top mode,radio wireless master mode, radio wireless slave mode, wireless optical slave mode (SC,SN,SC&SN,S1,S2)
Zoom :	Auto,20,24,28,35,50,70,80,105
Vertical rotation angle:	-7~150 degrees
Horizontal rotation angle:	0~360 degrees
Power supply:	4xAAsize batteries (Alkaline or Ni-MH are usable)
Lighting times:	100~1500 times (AA alkaline cell used)
Recycle time:	Approx 3s (AA alkaline cell used)
Flash color temperature:	5600k
Flash time:	1/200s~1/20000s
Flash control:	8 levels of output control (1/128~1/1), 29 levels of fine tuning
External interface:	Hot shoe, PC port
LED Color temperature:	Apporx. 5500K
LED luminance:	Apporx. 300lux(1m)
Optical transmission triggering distance:	20~25m indoor, 10~15m out door
Radio transmission triggering distance:	Up to 100m
Additional features:	Master flash, high-speed sync, second-curtain sync, FEC, FEB, FEL, the electronic flash head zooming, sound prompt, automatically saving setting, PC port, power saving mode, overheat protection, custom functions (C.Fn), personal functions(P.Fn).
Dimensions:	78×60.5×206mm(extended state)
Net weight:	435g
Contains items:	Speedlite(1) , protecting bag(1) , mini stand (1) , color conversion filter for LED light(1) , usermanual (1)

The functions of this user manual are based on test conditions of our company.Further notice will not be given if the design and specifications change.

The YONGNUO logo in this manual includes the registered trademark or trademark of Shenzhen Yongnuo Photography Equipment Co., Ltd in China or/and other countries(regions).All other trademarks are the property of their respective owners.